



UNITED NATIONS
UNIVERSITY

UNU-GTP

Geothermal Training Programme

Orkustofnun, Grensasvegur 9,
IS-108 Reykjavik, Iceland

Reports 2014
Number 17

WELL DESIGN, CEMENTING TECHNIQUES AND WELL WORK-OVER TO LAND DEEP PRODUCTION CASINGS IN THE MENENGAI FIELD

Abraham Wamala Khaemba

Geothermal Development Company, Ltd.

P.O. Box 17700-20100

Nakuru

KENYA

akhaemba@gdc.co.ke

ABSTRACT

Drilling has been ongoing at Menengai high temperature field since 2011. The wells are of regular well design with a 20" surface casing set at 60-70 m, 13 $\frac{3}{8}$ " anchor casing set at about 400 m depth and 9 $\frac{5}{8}$ " production casing set at between 800-1400 m. The intent is to drill the wells to a total depth of 2500-3000 m, with slotted 7" liners run to the bottom. All the casings used are grade K55, with threaded couplings.

Data from offset wells drilled earlier have helped design the depth of the production casing in order to avoid cold inflows into the wells. Wells located at the centre of the field, which is at a higher elevation, have production casings set at about 850 m, while the production casings for other wells have been designed to be set deeper, down to 1400 m.

With a good number of wells at the Menengai field having the production casing being set at 1400 m, this paper looks at: designing wells with a 9 $\frac{5}{8}$ " K55 production casing, slurry design and the most effective method for cementing the casings. Cementing methods that will be discussed include cementing with a cement head and plugs, two stage cementing, cementing with C-Flex RPL from the peak using the inner string method, reverse circulation cementing with an inner string and flap gate valve collar, and foam cementing.

The paper looks at a number of wells which have already been completed. Pressure and temperature logs are analysed as well as the borehole geology to identify the cold inflow zones in wells already drilled. The remedial mechanisms available for sealing off the cold zones in completed wells are then researched and the most effective method to be applied at the Menengai field identified. The methods include use of External casing packer (ECP) and tie back design.

1. INTRODUCTION

This paper will use data from the first twenty wells drilled at Menengai. All the wells are vertical and of standard size.

The design of Menengai wells, the drilling fluid program and the geology are shown in Figure 1. The wells are designed as follows:

- The conductor casing of diameter 30" is driven to ground at about 3 m.
- A 26" diameter hole is drilled to 80 m, then cased with 20" surface casing and cemented back to the surface.
- A 17½" diameter hole is drilled to a depth of 400 m. The 13¾" anchor casing is run and cemented back to the surface.
- A 12¼" diameter hole is drilled to between 800-1400 m; the 9-5/8" production casing is run and cemented back to surface.
- An 8½" production section is drilled to TD (total depth) of 2500-3000 m. A slotted 7" liner is then placed at the bottom of the 9 5/8" casing with a liner hanger which stretches down to the bottom of the production section.

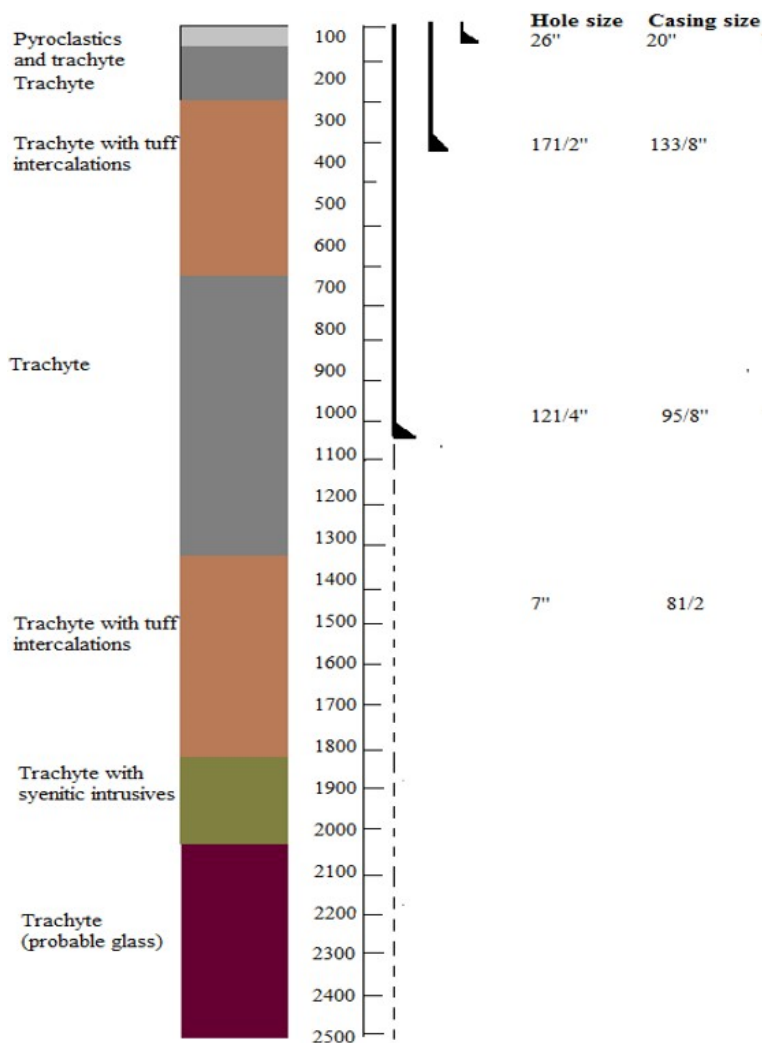

FIGURE 1: Menengai well cross-section with expected geology

The location of wells that have already been drilled in Menengai is shown on the geological map in Figure 2. The Menengai caldera is an elliptical depression with minor and major axes measuring about 11.5 km and 7.5 km, respectively. As per Mungania (2004), the circular rim of the caldera ring fault is well preserved with a vertical cliff at some places measuring up to about 400 m. The ring structure has only been disturbed by the Solai graben faults on the NE end and one fracture at the SSW end. The caldera floor is covered with post caldera lavas such that it is not possible to estimate the collapse depth or any structures that may mark the caldera floor. However, most of the caldera infill lavas are fissure eruptions that prefer fracture openings. The floor of the Menengai geothermal prospect area depicts extensional tectonics with the main trough trending N-S north of Menengai and NNW-SSE for the section south of Menengai. This sharp trend change is associated with the extent of Cambrian craton/orogenic belt contacts.

Wells located at the center of the field have their production casing depth between 800 m and 1100 m (Table 1). In most of these wells the casing has been sufficient to isolate cold zones. Wells drilled on the edge of the field have a deeper production casing set, from 1100 m to 1400 m, to isolate cold zones which could be as deep as around 1300 m.

The presence of cold zones below the production casing shoe indicates that the production casing has been set at a shallow depth.

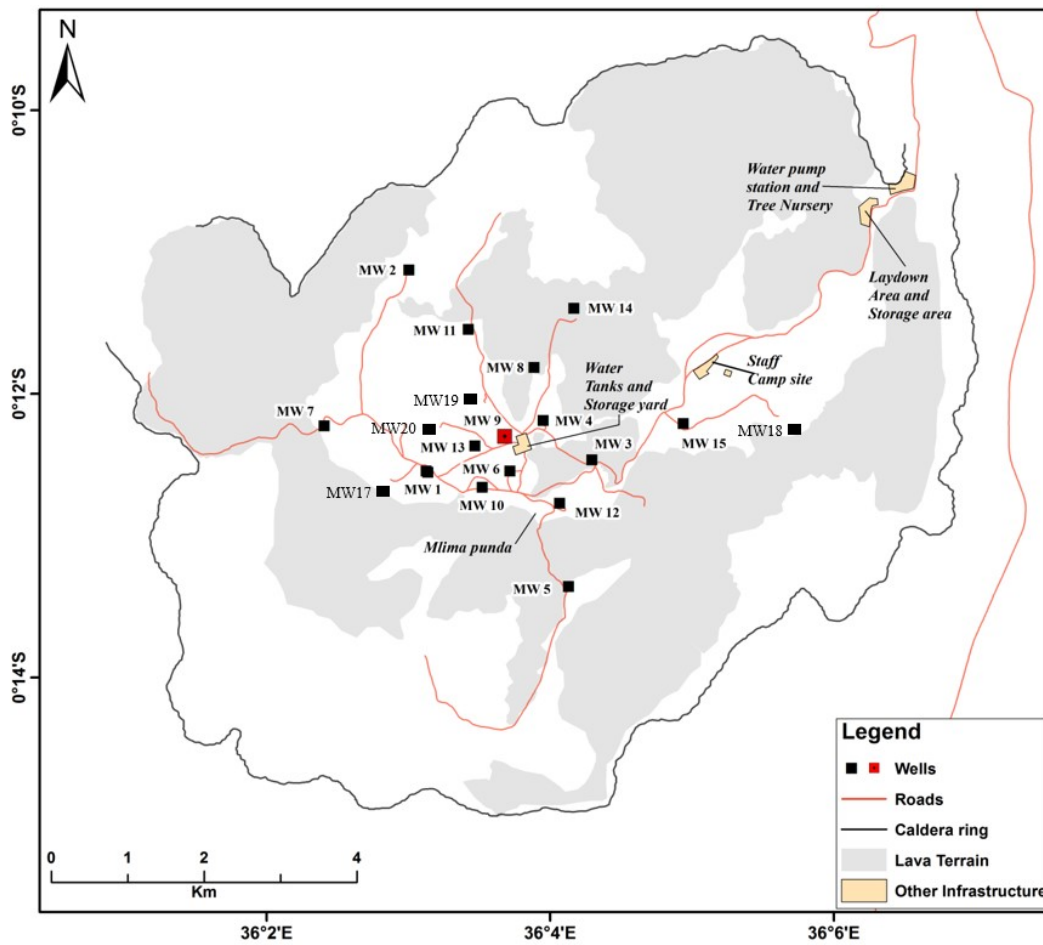

FIGURE 2: Map of Menengai showing drilled wells

TABLE 1: Wells data showing location, production casing depth and total drilled depth

Well	Location			Production casing depth (m)	Depth (m)
	Easting	Northing	Elevation (m)		
MW-01	171847	9977684.9	2064	842	2206
MW-02	171599.63	9979477.57	1898	802.04	3200
MW-03	177332	9977854.9	2032	1096.46	2117
MW-04	177331.4	997607	2085	1105.66	2096
MW-06	172853	997676.1	2095	1100.59	2202.96
MW-07	170488.1	9977450.9	1924	1179	2118
MW-08	173231.3	9978225.3	2015	928.05	2355
MW-09	172848	9977442.1	2105	867	2088
MW-12	172433.5	9976892.7	2106	854.5	2054.15
MW-11	172374	997536.1	1993	888.29	1842.37
MW-05A	173688	99777481	2052	862.64	2095.65
MW-15	175197.39	99777481.5	1959	946.27	1679.62
MW-13	172464	9977193	2081	856.34	2012.11
MW-16	171196	9978355	1965	1167.03	2414
MW-17	171275	9975756	2060	1004.57	2218.17
MW-19	172629	9977753	2085	847	2501.4
MW-20	172017	9977442	2105	1199.2	2461
MW-21	171473.52	9977800	2131.4	1302.85	2730
MW-22	172080	997780.79	2055	1329	2762
MW-10A	172016.79	9977442.1	2085	845	2161.45

2. LITERATURE REVIEW

2.1 Well design

Conditions to consider while designing wells include: sub surface conditions to be encountered, equipment to be used, material performance and the recognition of drilling practices needed to ensure performance. Design steps necessary to drill a deep well safely include:

- I. Taking geological and reservoir engineering advice on likely sub surface rock and fluid properties;
- II. Determining depths for casing and well completion;
- III. Selecting casing diameters, thicknesses, cementing materials and cementing programs;
- IV. Deciding on drilling fluids, drill string assemblies and well heads; and
- V. Nominating necessary equipment, tools, materials, support facilities and site requirements.

Particular geological information required for well design include:

- I. Rock type or formation, and the location of any specific stratigraphic marker beds;
- II. Compressive strengths and the degree of consolidation;
- III. Faulting, fracturing and gross permeability; and
- IV. Effects of drilling activities on formation like swelling of water sensitive clays.

The depth of all casings and liners are chosen to ensure safety and to safely contain well conditions from surface operations.

2.2 Casing design

The design of casings should include the effects of pressure and temperature changes that may occur at any time or depth during drilling or operation of the well. For each of the stress regimes, calculations should be done to establish that there is an adequate margin of strength in the casing string at all depths. Casing specifications should be selected or well conditions restricted to ensure that the minimum design factors are met. Information needed for the casing design include: mud weights, formation pressures, fracture gradients, casing seats, casing sizes, directional plans, cement program, temperature profiles and produced fluid chemical composition. Casing strings that are normally run include:

Conductor pipe: Run from the surface to shallow depths to protect near surface unconsolidated formations, seal off shallow water zones, provide protection against shallow gas flows and protect the foundation platform.

Surface casing: Run to prevent caving in of weak formations that are encountered at shallow depths. It should be set in competent rock. It provides protection against shallow blow outs and should be deep enough to support the BOP for drilling to the anchor casing shoe depth. This casing is used to case off poorly consolidated soil and loose material.

Anchor casing: Set in a transition zone, below or above an over pressurized zone to seal off a severe loss zone and protect against problematic formations. This casing protects surface aquifers against contamination during drilling and acts as a second pressure barrier during the life of the well. This casing supports the BOP and later the final production well head. Casing should be deep enough to allow for the well to be killed while drilling to the production casing depth.

Production casing: Run to isolate producing zones and provide reservoir fluid control. The casing is chosen on the basis of the expected depth and the temperatures of fluids to be included and isolated. It conveys steam and water to the surface.

Liner casing: string of casing that does not run to the surface but hangs inside the production casing. Can be slotted or perforated to allow reservoir fluid to flow into the well. Types of liners include: drilling liners, production liners, tie back liner, scab liner, scab tie back liner.

2.3 Casing diameter selection

The inside diameter of the casing should be selected to accommodate:

- Downhole equipment, liners and test gear required to complete the well;
- Drilling tools and fluids to drill the remainder of the well to completion;
- Sufficient annular clearances to run and cement concentric casing strings;
- Use of casing sizes which are standard and readily available on the market; and
- The geothermal fluid that flows to the surface during testing and production.

Note: While drilling the next whole section, it should be possible to achieve acceptable flow velocities inside the casings without high pressure losses. Drift diameters should be larger than the outside diameters of any tools and other equipment to be run through the casings. Casing pipe diameters are selected from API SPEC 5CT which specifies:

- Process of manufacture;
- Chemical composition;
- Mechanical properties;
- Testing procedures;
- Dimensions, weights and lengths;
- Threading and coupling;
- Inspection; and
- Markings.

2.4 Casing depth selection

The depth of production casing is determined by the depth at which fluids from the colder formations need to be isolated from entering the hole. One of the main determinants is the minimum depth for safety reasons. Government regulations at times specify minimum casing depth. From a technical point of view, the four main criteria used are:

- In the *New Zealand code of practice* the criteria is that the pressure from the overburden (soil) at the last casing shoe shall exceed the pressure from a steam filled well. Once the final depth of the well has been decided, hydrostatic pressure for the Boiling point-depth curve (BPDC) is drawn to that depth. Minimum depth of casing according to the (NZS, 1991) method is then found by extending the bottom hole pressure up the well until it intersects the overburden line. This will be the minimum production casing depth. By repeating the procedure, casing depths for the anchor and surface casings can be determined as shown in Figure 3.
- In Iceland, a BPD is assumed for new fields. From well simulation the pressure profile for a flowing well is determined assuming inflow at the bottom. Liquid will immediately be transformed into a

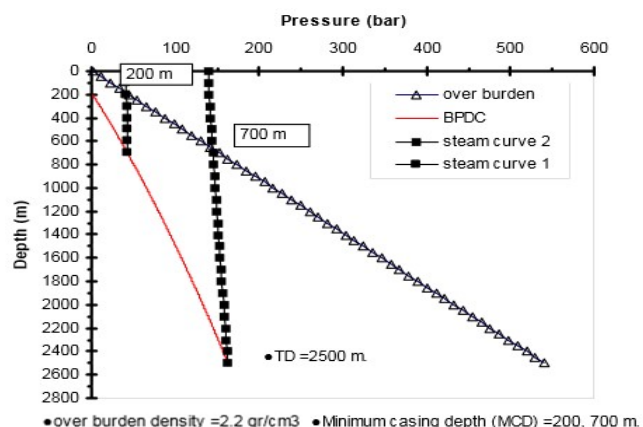

FIGURE 3: The New Zealand method to determine minimum casing depth (Hosseini-Pourazad, 2005)

two phase flow up the well. Minimum casing depth is determined by how long a column of heavy mud 1.4g/cm^3 is required to balance this pressure, shown in Figure 4.

III. Another criterion is to use the actual downhole temperature and pressure measurements. Typically, fluid turns to two phase flow halfway up the hole. This pressure profile is balanced by pure water only. Pumping only water into the well ensures the drill string can be retrieved, even if there is an underground blow out in the well, as shown in Figure 5.

2.5 Casing materials

Steel casings are selected from API SPEC 5CT or 5L. Where gases are present, casing materials are selected to minimize possibilities of failure by hydrogen embrittlement or by sulphide stress corrosion cracking.

Where axial strength is important, casing joints shall be API buttresses with proven strength in both tension and compression. The casing design should allow for changes in casing properties at elevated temperatures including tensile yield and ultimate strengths. The effects of plastic yield and of stress relaxation with time should be considered when programming casing settings, well operation procedures and workovers.

2.6 Casing service conditions and failure modes

According to Hole (2008), the effects of elevated temperatures on well components such as casings include:

- Change in the length of unrestrained casing;
- Compressive stress due to restriction (cemented casing);
- Reduction in steel strength; and
- Destruction in material competence, particularly flexible seals.

Factors affecting casing loading during different operations are shown in Table 2.

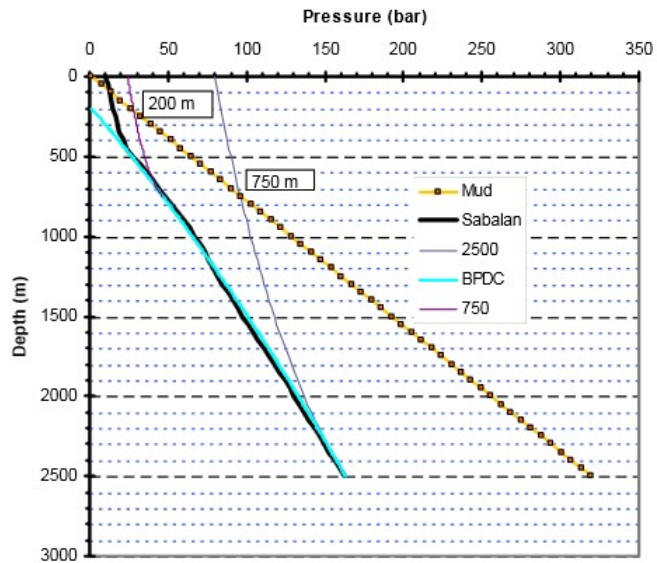

FIGURE 5: Icelandic method of determining casing depth using mud as a blowout preventer (Hossein-Pourazad, 2005)

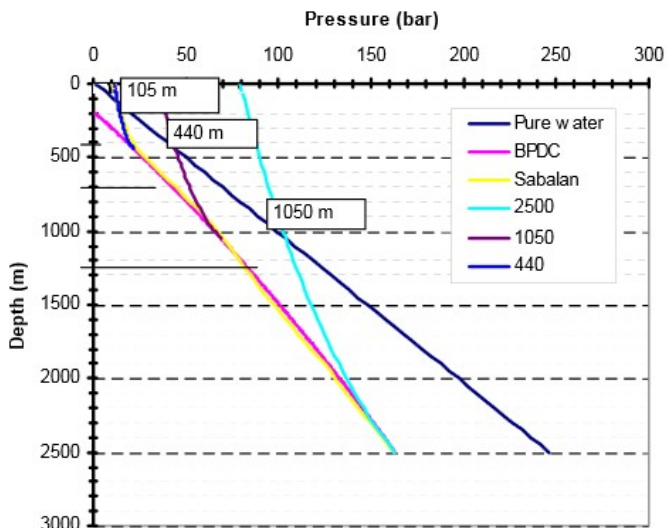

FIGURE 5: Icelandic method to determine the minimum depth of casing using pure water as a blow out preventer (Hossein-Pourazad, 2005)

TABLE 2: Factors affecting casing loading (Southon, 2005)

Stress	Installation	Injection	Production
Collapse	Cement column outside and water inside the casing; Biaxial tension	Biaxial load	Trapped water in uncemented sections in annulus
Burst	Surface pressure to lift cement; Gas accumulation	Injection pressure; Gas accumulation and depression of water table	Well head pressure
Tension/ compression	Cooling load; support of own weight	Axial load due to cooling	Thermal expansion

The different factors lead to primary modes of failure which are divided into axial and radial failures.

2.6.1 Axial stress conditions

Axial stress occurs due to:

- Casing self-weight;
- Temperature effects - Expansion and contraction; and
- Restraint from surrounding cement and connection of well head or hanger at the bottom.

Axial loading before and during cementing

Tensile force at any depth includes the weight of casing in air minus the buoyant effect of any fluid in the well until the annular cement sets:

$$F_p = \left[L_z W_z - (L_z - L_w) \frac{A_p}{n} \right] g \quad (1)$$

where F_p = Tensile force at surface from casing weight;
 L_z = Depth of casing;
 W_z = Unit weight of casing;
 L_w = Depth of water level in the well;
 A_p = Cross-sectional area of pipe;
 n = Mean specific volume of hot fluid; and
 g = Acceleration due to gravity.

The design factor applied is 1.8.

Axial loading after cementing

Thermal stresses can be calculated by imagining that casing expands outwards and then is forced back to its original length by axial compression (using the modulus of elasticity). The total axial stress in a cemented string varies continuously with depth and also with differences in temperature.

The compressive force due to temperature rise when the casing is constrained both longitudinally and laterally by cement is:

$$F_c = C_t [T_2 - T_1] A_p \quad (2)$$

where C_t = $Ea = 200 * 12 * 10^{-6} = 2.4 \text{ Mpa}/^\circ\text{C}$;
 F_c = Compressive force due to heating;
 C_t = Thermal stress constant for casing steel;
 T_1 = Neutral temperature (time cement sets);
 T_2 = Maximum expected temperature;
 A_p = Cross-sectional area of pipe;
 E = Modulus of elasticity; and
 a = Coefficient of linear thermal expansion.

The tensile loading, as calculated for the pre-cementing axial loading, remains in the casing after the cement sets up (ignoring stress relaxation with time); the resultant axial force (F_r) after cement set up and heating will be:

$$F_r = F_c - F_p \quad (3)$$

where F_r = Resultant axial force

The design factor utilised will be the minimum compressive strength/resultant compressive strength. The design factor should not be less than 1.2. The minimum strength refers to the lesser strength of the pipe body or connection.

Axial loading with buckling and bending

This section applies to the setting of liners. Liners are either hung in tension using a liner hanger or sit on the bottom of the well; in this case the liner is in compression. The liner is not cemented so it is not radially supported or constrained. The liners are subjected to axial self-weight compression and helical buckling, analysed for extreme fibre compressive stress:

$$F_c = LzWp g \left[\frac{1}{A_p} + \left(\frac{De}{2Lp} \right) \right] \quad (4)$$

where F_c = Total extreme fibre compressive stress due to axial and bending forces;
 Lz = Length of liner;
 Wp = Nominal unit weight of casing;
 g = Acceleration due to gravity;
 A_p = Cross-sectional area of pipe;
 D = Pipe outside diameter;
 e = Eccentricity (actual hole diameter minus D); and
 Lp = Net moment of inertia of pipe section, allowing for slotting or perforation.

The design factor should not be less than 1.

2.6.2 Radial stress conditions

Radial (Hoop or circumferential) loadings are applied primarily by internal and external fluid pressures. The ability of casings to resist the resultant differential pressures is listed in the API standards. Consideration must be given to:

- The differential pressures that occur before and during cementing operations
- Well fluid pressures in static conditions or when producing or reinjecting

Internal yield – Bursting

The design must ensure that adequate safety margins exist against internal yield or burst from high internal fluid pressure caused by a range of situations during and after cementing. Maximum differential burst pressures usually occur near the casing shoe or stage cementing collar ports and will apply when:

- The casing is filled with high density cement;
- The annulus is either completely filled with water back to the surface or partially filled with water as controlled by formation pressure;
- A restriction within the casing, such as a blocked float valve or a cementing plug which will hold differential pressure.

This is the worst case scenario; the hydrostatic pressure inside the casing at the shoe is caused by cement slurry and applied pressure minus the hydrostatic pressure in the annulus caused by the head of water in the annulus:

$$P_i = [(L_f G_f + P_p) - (L_z G_z)]g \quad (5)$$

where P_i = Maximum differential internal pressure;
 L_f = Height above casing shoe of the cement column;
 G_f = Cement slurry density;
 P_p = Applied pumping pressure;
 L_z = Height above casing shoe of water column in the annulus;
 G_z = Mean density of water in the annulus.

Design factor = Casing internal yield pressure/Differential burst pressure and should not be less than 1.5.

Collapse

The casing design should ensure a sufficient margin of safety against collapse due to external pressure from entrapped liquid expansion, applied pressure during pumping or static pressure from a dense liquid column such as cement slurry. Maximum differential external pressure occurs at the completion of displacement. The annulus is completely filled with high density slurry while the inside of the casing is filled with water.

$$P_z = [(L_z G_z + P_p) - (L_f G_f)]g \quad (6)$$

where P_z = Maximum differential external pressure;
 L_f = Height above casing shoe of water column inside the casing;
 G_f = Mean density of water inside the casing;
 P_p = Applied pumping pressure;
 L_z = Height above casing shoe of cement slurry column in annulus;
 G_z = Mean density of cement slurry in annulus;

The design factor = Casing collapse strength/net external pressure and shall not be less than 1.2.

2.7 Cement slurry design

Casings are cemented the full length to the surface to minimize casing expansion, especially during production. Slurry design depends on well information from logs and drilling operations such as:

- I. Temperature measurements. They provide valuable information for cementing such as in the determination of hole temperature, the location of aquifers and loss zones, the cross flow between aquifers, and locating the top of the cement. Both the bottom hole circulating temperature (BHCT) and bottom hole static temperature (BHST) should be determined. The temperature measured should be similar to conditions at the time of cementing.
- II. Caliper log. Measures well diameter; usually with 4 arms to investigate cavities, the amount of cement needed for cementing, and used in order to determine the location of packers.
- III. Cement bond logs. Done after cementing to determine the top of the cement, cement quality, and bonding of the cement to the casing and hole wall.

The design of cement slurry for a geothermal well considers a careful choice of cements, retarders, fluid loss additives, dispersants, silica flour, extenders, bentonite, mica flakes, friction reducer, calcium chloride, defoamers and mix water. Slurry should also be correctly placed in the annulus. Mainly Portland cement is used in the Menangai area. Slurry properties considered before cementing include:

- I. Slurry density (SG);
- II. Slurry yield (m^3/mT);
- III. Thickening time at bottom hole circulating temperature and bottom hole static temperature;
- IV. Fluid loss (mL);
- V. Free water composition (%);
- VI. Test pressure;
- VII. Compressive strength (MPa); and
- VIII. Filtration.

The slurry properties should be adequately tested in the laboratory to ensure the slurry meets stated conditions. The cement slurry should be monitored and measured during cementing to ensure that the concentrations of solids and additives are maintained as close as possible to design values. Use of high strength microspheres (HSM) is used to make low specific gravity slurries that can withstand high pressures. These slurries maintain low density at high pressures and still develop high compressive strength over a broad temperature range. There are new slurry techniques to improve the quality of slurry such as:

- Fibre reinforced cement slurry - Fibre improves cement toughness as a result of improved interfacial shear strength between the hydrated cement and fibre. Fibre reinforced cements are able to withstand higher tensile stresses than conventional cements and increases tensile strength and strain capacity, flexural and shear strength, ductility, toughness and resistance to cracking induced by thermal effects, shrinkage or other causes.
- Hollow microsphere slurry – Has a low specific gravity and can withstand high pressures. This allows for the use of cement designs that can maintain low density at high pressures and still develop relatively high compressive strength over a broad temperature range.
- Foamed cement slurry – Mixture of cement slurry with foaming agents and gas, usually nitrogen which is injected at high pressure into the base slurry and incorporates a foaming agent and foam stabilizer. The small, fine foam bubbles promote stronger cement walls around the bubbles and promote the setting of cement with increased integrity. The process creates stable lightweight slurry with low permeability and relatively high compressive strength.

2.8 Cement placement methods

2.8.1 Single stage cementing

Single stage cementing is the most common cementing operation used in geothermal drilling. The procedure, as shown in Figure 6, involves:

- Casing string with all the required cementing accessories such as float collar, guide/float shoe and centralizers are lowered in the well, with a few metres of rat hole left at the bottom.
- Cementing head is connected at the top of the casing. Cement plugs should be correctly placed in the cementing head.

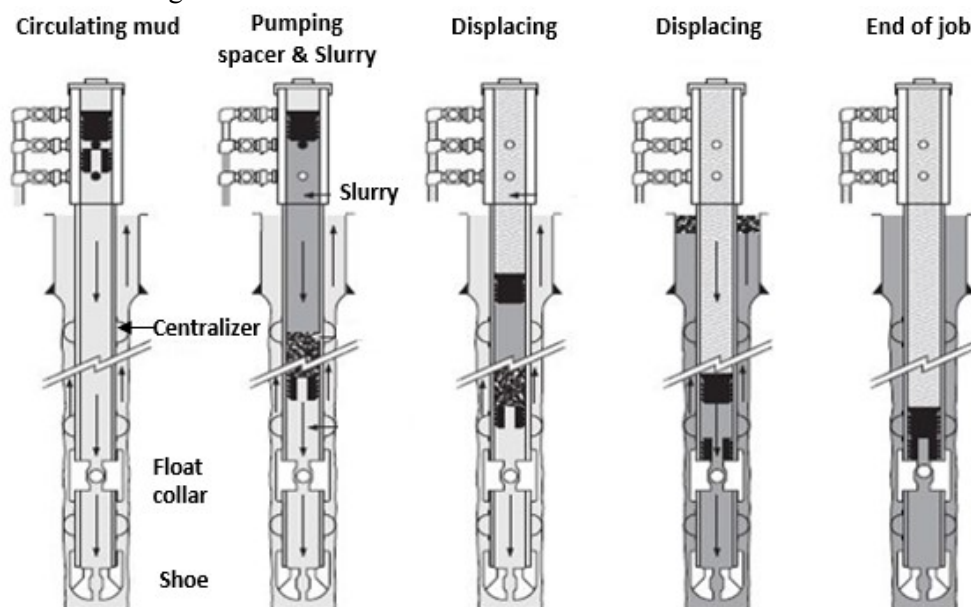

FIGURE 6: Single stage cementing procedure (Bett, 2010)

- The casing is circulated clean before cementing and thoroughly cooled.
- Bottom plug is released to wipe the casing clean and to form a barrier between the spacer and the drilling fluid in the casing, followed by a spacer and then cement slurry. When the bottom plug reaches the float collar, the diaphragm ruptures, allowing the spacer and slurry to flow through the plug, around the shoe, and then up the annulus.
- The top plug is released and displacing fluid is pumped. When the plug reaches the float collar, it lands on the bottom plug and stops the displacement process.

2.8.2 Inner string (Stinger) cementing

Inner string cementing allows large diameter casing to be cemented through the drill pipe or tubing that is inserted and sealed in floating equipment. Inner string cementing requires the installation of a stab in the casing string. A float collar with a sealing sleeve is usually installed two joints from the bottom of the casing string.

Casing is run into the well the normal way; then the inner string is run with a sealing adapter made up on the lower end and stabbed into the floating equipment to provide sealing/bore receptacle for the inner string sealing adapter. After stabbing in, water is circulated around the system to ensure that the stinger and annulus are clear of any debris and to cool down the well. This is followed by a spacer before slurry is pumped. The inner string cementing set up is shown in Figure 7.

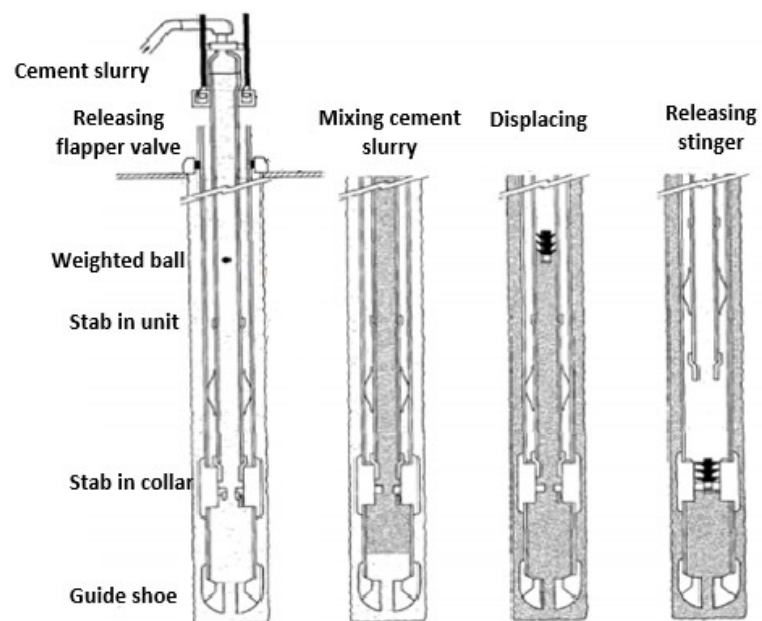

FIGURE 7: Inner string cementing and reverse cementing (Nelson, 1990)

Displacement of the slurry can be done with or without a plug. Inner string cementing has these advantages:

- I. Reduces the risk of cement slurry setting within the casing since cement reaches the annulus much faster than in conventional cementing methods;
- II. Does not require large diameter cementing plugs;
- III. Reduces cement contamination;
- IV. Reduces the amount of cement that has to be drilled out of large diameter casing;
- V. Decreases cementing displacement time; and
- VI. Allows cement slurry to be pumped until returns are obtained on the surface.

2.8.3 Reverse circulation cementing

Reverse circulation cementing is mainly used in well bores where loss of circulation is encountered. Slurry is pumped down the annulus, displacing the drilling fluid back up through the casing. The float equipment, differential fill up equipment and well head equipment must be modified. Reverse circulation can provide the following advantages:

- I. Reduces hydraulic horse power of cement slurry pumping equipment since gravitational flow works in favour of the slurry flow;
- II. Reduces the fluid pressure (Equivalent circulating density-ECD). ECD is calculated at the shoe by combining the effects of hydrostatic pressure and frictional fluid induced pressures in the casing. This is because the heavier and more viscous cement slurry is not circulated back to the surface through the casing;
- III. Enables shorter slurry thickening time since little or no retarders are used; and
- IV. Takes a shorter time to execute since no displacement is required.

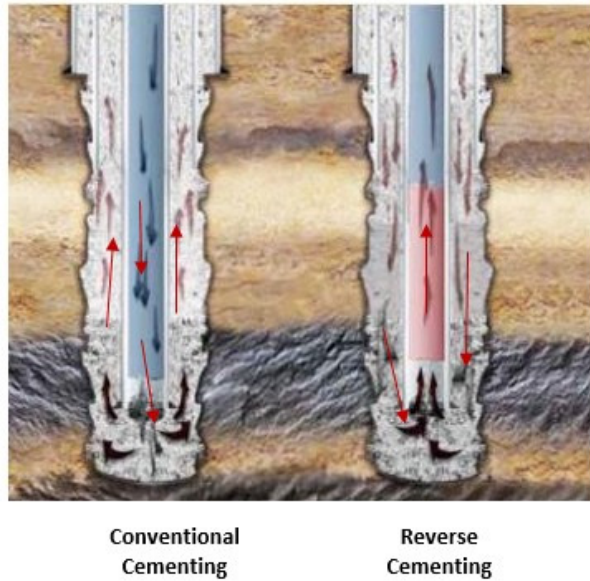

FIGURE 8: Reverse cementing (Nelson, 1990)

The main disadvantage of this method is that it is hard to ensure good cementing at the shoe. Reverse cementing is shown in Figure 8.

2.8.4 Two stage cementing

Two stage cementing makes use of a stage cementing collar in addition to the conventional cementing equipment (guide shoe and float). The procedure for conducting a two stage cementing operation is shown by Nelson (1990).

Cementing the First stage

Mixing and pumping of spacers and slurries during the first stage is similar to a single stage operation. After slurry mixing, the first stage plug is dropped and displaced until a positive indication of its landing in the float occurs. Some operators, when cementing production casings, displace the first stage using two fluids, leaving the casing below the stage collar filled with completion fluid and the upper casing filled with drilling mud. This mud is subsequently used to circulate the hole through the stage collar ports. Some types of stage collars allow the use of first stage wiper plugs.

Cementing Second stage

After the first stage is completed, the opening bomb is dropped and allowed to fall via gravity to the lower seat in the stage collar. Once the bomb is seated, pressure is applied until the retaining pins are sheared, forcing the lower sleeve to move downwards and uncover the ports. Usually a pressure of 1200 to 1500 psi will shear the retaining pins. A sudden drop in surface pressure indicates the opening of the ports. Once the ports of the stage collar have been opened, the well must be circulated until the mud is conditioned for the second stage. For cementing the second stage, spacers and slurries are mixed as in any single stage job. The closing plug is dropped after slurry mixing and is displaced to its seat in the stage collar. After the plug has seated, a minimum of 1500 psi above the second stage displacing pressure is required to close the stage-collar ports. Pressure is released from the casing after the ports are closed. Most second stages of two stage jobs are performed using low density filler slurries to allow circulation to the surface. Tail slurries are rarely used even if an open hole section is to be cemented. For the protection of the weakest part of the casing string, the stage collar is improved by increasing the density of the last portion of the cement slurry. Two stage cementing is shown in Figure 9.

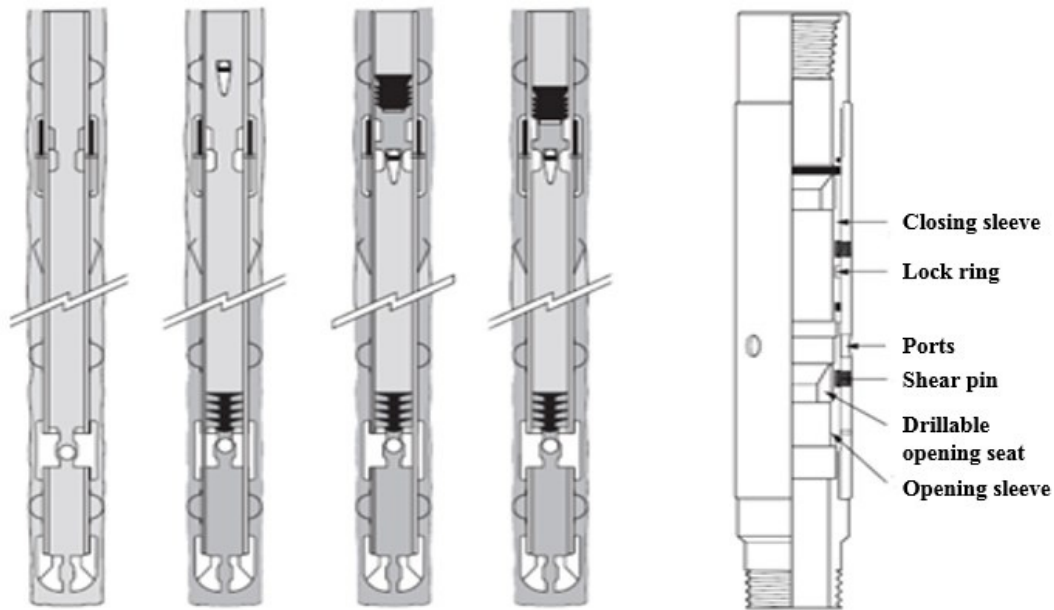

FIGURE 9: Two stage cementing procedure (Bett, 2010)

3. ANALYSIS OF MENENGAI WELLS

From temperature profiles of wells drilled at Menengai, from completion tests, during heat up and after discharge, the temperature along the wells can be noted and feed zones identified. This study takes a look at two wells: Menengai MW02, located on the edge of the field, with a production casing at 802.04 m, and Menengai MW19 at the centre of the field with a production casing at 847 m. The two wells have production casings set at a shallow depth than other wells in the field.

3.1 Menengai MW02

Menengai well MW02 was completed on 1st May 2011. Aquifers in MW02 were observed in zones shown by changes in the temperature logs. In addition, they were also characterised by an increase in circulation losses of drilling fluid, an increased proportion of high-temperature hydrothermal alteration minerals and changes in the penetration rates. Well MW02 encountered aquifers with relatively low temperature (<80°C) at 400-600 m and 1100-1300 m. Four aquifers were notable at 500 m (~75°C), 1200 m (~80°C), 2300 m (~90°C) and 3200 (~120°C). Figure 10 shows temperature and pressure plots for well MW02 during heating up after drilling.

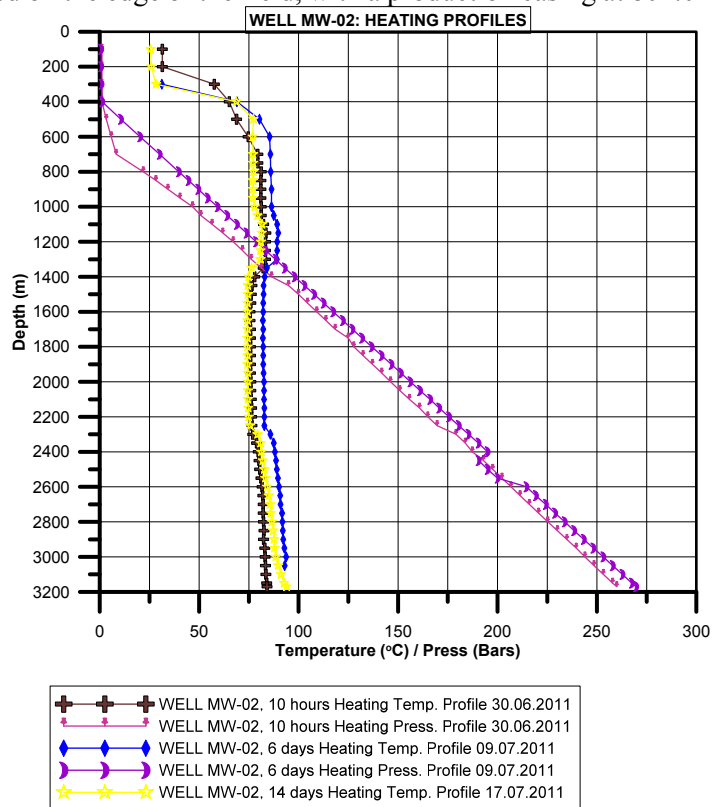

FIGURE 10: Menengai Well MW02 Temperature-pressure profiles

The well is located right at the western promontory fault, almost at the edge of the caldera floor, as shown in Figure 2. The rock formations in the well are heavily fractured and pyritized with partial circulation losses all through the well column. There is a sudden inflow of warm water into the well at 2300 m. There is an increase in temperature at 3100 m, implying a hot geothermal reservoir beneath the massive intrusion.

Temperature logs show an increase at about 1100 m of slightly hotter water flowing into the well. At about 1300 m, cold water flows into the well and, at about 2250 m, hot water (probably only just above 100°C) flows in and mixes with the cold water. At about 3000 m, the water flows out of the well. The rock formation between 1300 and 2250 m seems relatively cold but significantly hotter below 3000 m, according to Njue (2013).

3.2 Menengai well MW19

Menengai well 19 (MW19) was completed on the 12th December 2013. In well MW19, high temperature alteration minerals epidote, wollastonite and actinolite, indicating temperatures of 250°C, appear from a depth of 1464 m. Wollastonite is noted from depths of 1464 m to 1504 m. The well has several feed zones. The upper feed zones are at 500 m, 900 m and 1300 m. These feed zones have a cold zone up to 1300 m, thus the well needed to be cased off and the deeper feed zones in the well utilized. After 14

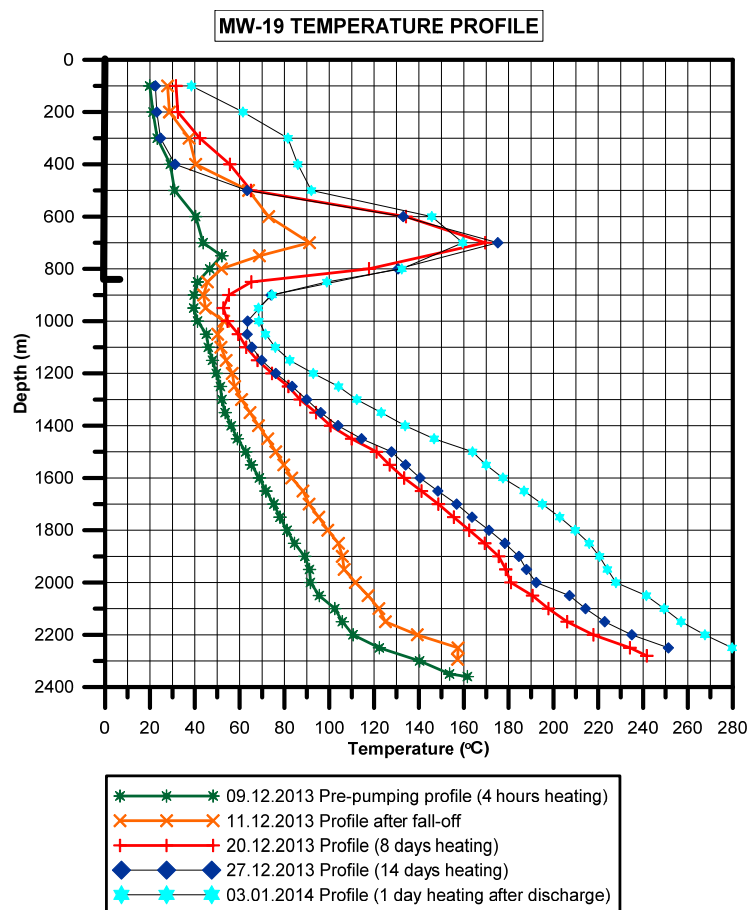

days of heating up, the upper reservoir between 800 m and 1000 m had temperatures up to and above 170°C while, after 1 day of discharge, the temperatures at the bottom of the well reached 280°C, as shown in plots in Figure 11.

Data from the two wells shows the presence of more than one aquifer in the wells. There is an upper aquifer and a lower aquifer with a cold zone between them from 1000-1300 m in both wells. The presence of a cold zone which has not been cased off has had an effect on the production of the wells, resulting in the need to land deep production casings up to a depth of 1400 m and to cement the casing for an effective and durable well (Lopeyok, 2014).

Because of the relatively low temperature in the upper zone, production has led to the precipitation of calcite in some wells, leading to a decrease in production and, hence, to costly workovers.

FIGURE 11: Menengai MW19 well profile after drilling

4. MENENGAI PRODUCTION CASING DESIGN AND CEMENTING

4.1 Casing design calculations

Grade K55 casings are used. K55 casing properties are shown in Table 3, while standard parameters for calculating casing loading are shown in Table 4.

TABLE 3: K55 Casing properties

Casing size (inches)	20	13 ³ / ₈	13 ³ / ₈	9 ⁵ / ₈	7
Grade	K55	K55	K55	K55	K55
Weight, PPF	94	54.5	68	47	26
Inside diameter, Inches	19.124	12.615	12.415	8.681	6.276
Drift diameter, Inches	18.936	12.459	12.259	8.525	6.151
Collapse, PSI	520	1130	1,950	3,880	4,320
Burst, PSI	2,110	2730	3,450	4,720	4,980
Burst with 1.1 DF PSI	1918	2482	3136	4291	
Tensile, KLBS	1,480	853	1,069	746	415
Thread type	BTC	BTC	BTC	BTC	BTC

TABLE 4: Parameters used to calculate production casing loading

Parameter		Parameter	
Size	9.625 inches	Casing capacity	38.18 l/m
Depth	1400 m	Gravity	9.810665 m/s ²
Casing wall thickness	0.472 inches	Density of water	1 SG (1000 kg/m ³)
Casing weight	47 pounds/foot	Density of cement	1.8 SG (1800 kg/m ³)
Casing grade	API-K55	Thermal stress constant for steel	2.4 Mpa/°C
Collapse resistance	26.8 MPa	Pipe body strength	332 daN * 10 ³
Internal yield	32.5 MPa	Casing cross sectional area	8756 mm ²

Axial loading before and during cementing will be calculated using Equation 1. The worst case theoretical axial load when cementing is when the casing is full of cement and the annulus is full of water.

TABLE 5: Conversion constants

Total axial load = Casing self-weight + Weight of casing – Buoyancy

For calculations in standard units, the conversion factors are shown in Table 5.

Tensile

Tensile loading during primary cementing, while the casing is full of cement, is found using Equation 1:

$$i.e. \quad F_p = \left[L_z W_z - (L_z - L_w) \frac{A_p}{n} \right] g \quad (\text{Tensile loading at the surface from casing weight})$$

$$\text{Casing self-weight} = \text{Depth} * \text{Weight} \left(\frac{3.28084}{2.2482014} \right) \text{ daN}$$

$$= 1400 * 47 * 1.4593 = 96,023.10 \text{ daN}$$

$$\text{Weight of cement} = \text{Depth} * \text{Capacity} * \text{Density} = 1400 * 38.19 * 1.8 = 96,238.8 \text{ daN}$$

Conversion factors	
m to feet	3.28084
daN to lbf	2.2482014
kgf to daN	0.9810665
inches to cm	2.54
inches to m	0.0254
N to daN	0.1

$$\text{Buoyancy Force} = \text{Density of Fluid} * \text{Volume displaced (Cross-sectional Area} * \text{Depth)} * \\ \text{Acceleration due to gravity} = 1400 * \left[\frac{(9.625 * 0.0254)^2 * 3.142}{4} \right] * 1000 * 0.981 = 64,478.087 \text{ daN}$$

$$\text{Total axial load} = \text{Casing self-weight} + \text{Weight of cement} - \text{Buoyancy} \\ = 96,023.10 + 96,238.8 - 64,478.087 = 127,783.813 \text{ daN}$$

K55 casing body yield strength = 332,000 daN (Gabolde and Nguyen, 2014)

$$\text{Safety Factor} = \frac{332,000}{127,783.183} = 2.598$$

With the safety factor at the recommended minimum of 1.8, it is safe to run 9⁵/₈" , grade K55, 47 lb/ft. Casing to 1400 was recommended by Hole (2008).

Yield

Internal yield pressure while cementing to 1400 m (Burst) is calculated using Equation 5:

$$\text{The maximum differential pressure} = [(1400 * 1800) - (1400 * 1000)]9.81 = 10.987 \text{ MPa.}$$

Design limit for 9⁵/₈" , grade K55, 47 lb/ft. casing is 32.5 MPa (Gabolde and Nguyen, 2014).

$$\text{Safety factor} = \frac{32.5}{10.987} = 2.96, \text{ above the design Factor of Safety as shown in Hole (2008).}$$

Collapse

Collapse during cementing using Equation 5:

The maximum differential pressure = [(1400 * 1000) - (1400 * 1800)]9.81 = -10.987. The pressure could be less depending on pumping pressure while displacing.

Design collapse resistance for 9⁵/₈" , grade K55, 47 lb/ft. casing is 26.8 Mpa (Gabolde and Nguyen, 2014).

$$\text{Safety factor} = \frac{26.8}{10.987} = 2.43$$

It is safe to run 9⁵/₈" , grade K55, 47 lb/ft. casings to 1400 m, since the factor of safety is above the design factor of safety of 1.2 from Hole (2008).

All the casings have Buttress thread connections. They have a longer thread and coupling run out and the threads are squarer resulting in a stronger connection than the strength of the casing body. The connection is stronger, 445 and 416 *10³ for buttress standard and buttress special clearance, respectively (Gabolde and Nguyen, 2014), thus the connection is safe to run K55, 9⁵/₈" , 47 ppf casing to 1400 m. A thread compound should be used to provide a sealing mechanism.

Rig capacity

There are two types of rigs in use at Menengai, the 2,000HP rig with a hook load capacity of 450 tons (Bomco, 2011), and an Atlas Copco rig with a hook load capacity of 91 tons (Atlas Copco, 2011).

K55, 9⁵/₈" , 47 lb/ft. casings have a nominal weight of 69.944 kg/m; running the casings to a depth of 1400 m, the total weight of the casings will be 97,921.6 kg. Since the total weight of the casings is beyond the limit of the predator rig, the casings can only be run using the 2,000 HP rigs.

4.2 Effective cementing method

In Menengai only single stage cementing has been used. Casings are run with shoe and float placed one joint off the bottom. The wells are circulated to clear the annulus and cool down the wells before the

cementing lines are pressure tested to 1500 psi (10 MPa). Pre-flush fluid is pumped at 1.00 SG, then the spacer at 1.5 SG. The lead slurry is mixed in the cementing equipment and pumped at about 1.72 SG with the tail slurry being pumped at 1.85 SG. The density is checked using a pressurized mud balance on the cementing unit.

The wiper plug is bumped then displaced with the casing capacity volume. Pressures are recorded while displacing and before bumping the plug. If returns are not received on the surface, the annulus is flushed with water and then the cement top fill is done after 8 hours. Top jobs are done until cement returns are received on the surface. The cementing procedure that has been in use at Menengai is illustrated in Appendix I. Cement bond logging has not been done, but the top of the cement is noted before commencement of drilling the next hole section. Instances have been recorded where the plug is tagged at a specific depth but there is no cement between the plug and the shoe. In Figure 12, the graph shows that in most cases the cementing was not effective since cement was tagged at a greater depth than the expected top of the cement depth. This could be an indication that the cement was not properly displaced.



FIGURE 12: Graph showing comparison of actual top of cement and expected top of cement depths inside the production casing

Using inner string cementing to the loss zone is a more appropriate cementing method. While using single stage cementing, displacing the cement has been a challenge. While displacing the cement in the large diameter casings, in most instances water separates from the cement and free water has been found below the top plug used while displacing the cement. An inner string cementing method is more appropriate since cement is displaced more effectively as the displacement capacity of the drill pipes is a lot less than in the casings, thus we can displace faster. Water should be pumped through the annulus at a constant rate to ensure the loss zone remains open; then cement should be pumped to the loss zone. The primary cementing job should be followed immediately with a backfill targeted to fill up the annulus to the surface while the annular rams on the BOP are closed. The inner string method is more advantageous as it is faster to circulate and cool the well since circulation is done through drill pipes (capacity of 9.05 l/m) (Gabolde and Nguyen, 2014), while in single stage cementing circulation is done through the 9 $\frac{5}{8}$ " casing (capacity of 38.18 l/m) (Gabolde and Nguyen, 2014), which takes more circulation time and has less annular pressure for lifting cuttings that may have dropped below the shoe. Due to the differences in the capacities, it takes shorter time to perform inner string cementing.

Cement test results, as shown in Appendices II and III, confirm that the cement slurry is suitably designed to for cementing deep production casings with high formation static temperatures of $\sim 150^{\circ}\text{C}$.

Cement should be tagged after 6 hours. If the cement level has dropped, the cement should be filled up to the surface by pumping via the kill line.

After the cement has set, a cement bond log should be carried out to evaluate the quality of the cementing job and to ascertain if any remedial work must be done before drilling the next hole section.

5. CASE STUDY OF DEEP PRODUCTION CASINGS

5.1 Krafla geothermal field and the IDDP-1 well

5.1.1 Krafla field

Krafla geothermal field is located within the northeast volcanic zone of Iceland. The Krafla fissure swarm, which is presently active, extends from Tjörnes Fracture Zone in the Öxafjörður bay in the north and some 100 km to the south. Its width is approximately 5 km but varies considerably along the swarm. The high temperature geothermal field is located within the Krafla caldera, elongated in an EW-NS direction.

Drilling of exploratory wells in Krafla started in 1974. In some of the wells a temperature of 310° C was measured and it was assumed that the temperature of the system was close to the boiling point curve. Two distinct zones exist in Krafla: a lower zone, (1100 – 1300 m to at least 2200 m), is the up flowing zone which feeds the upper zone (extending down to 1100 m depth). The upper zone is water dominated and has a mean temperature of 205°C, whereas the lower zone is a two-phase system with temperatures ranging from 300°C to 350°C. Because of the relatively low temperature in the upper zone, production from this level caused calcite precipitation in the wells. As a result, production in Krafla has mostly been limited to the lower zone (Stefánsson and Steingrímsson, 1980). The first signs of boiling in the wells can be found during the warming up period. Boiling aquifers usually recover faster than other parts of a well and boiling begins in the aquifers in a well. This boiling initiates convection in the well and heats up the column above the boiling aquifer until the temperature aligns to the boiling point curve. Some of the wells, for instance well KJ-11, had two modes of flow. One mode was where only the liquid-dominated zone contributed to the flow, and the other mode was where both zones were active. This contributes to considerable cooling in the well. Well IDDP-1 was designed to tap steam from supercritical geothermal systems for wells with higher temperatures and more pressure for higher electric power output.

5.1.2 IDDP-1 well design

The drill plan for well IDDP-1 is shown in Figure 13 for a standard hole. Actual drilling of the well was done from 2008 to 2009. The surface and intermediate casings were set as per plan. However, a 13³/₈" anchor casing was set at 1957 m instead of the planned 2400 m due to drilling problems like a stuck string, twist offs, unsuccessful fishing attempts and side-tracking 3 times. The well was completed with a cemented 9⁵/₈" sacrificial casing and a 9⁵/₈" slotted liner set a few meters above quenched magma. The well was drilled to 2104 m. It was deemed not feasible to continue drilling well IDDP-1 (Elders and Fridleifsson, 2010).

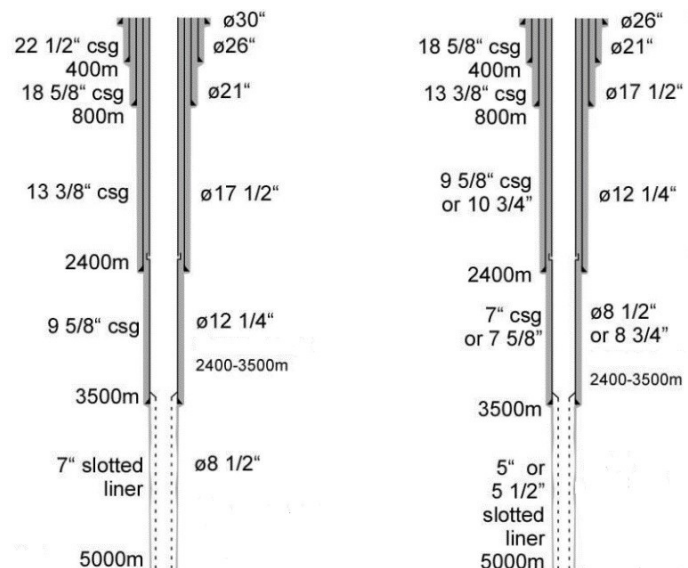

FIGURE13: IDDP-1 initial well design
(Thórhallsson et al., 2010)

5.1.3 IDDP-1 casing design

Casing strings

Two casing programmes of different diameters were evaluated, as shown in Figure 13. The design used casings available in the industry for both the standard hole and slim hole wells.

Design loads

Casings were designed to contain extreme conditions of a flowing well as well as a closed well. Design loads for these casings were calculated. Design factors considered were selected casing depths, highest temperature range and the saturation pressure at the highest temperature.

Internal yield pressure

Internal yield pressure was calculated in accordance with Section 4.1.1 of the API (1994); the findings are shown in Table 6.

TABLE 6: Internal yield pressure and well head shut in pressure

	Units	Well profile A		Well profile B	
Anchor casing	In/lb/ft.	13 ³ / ₈ "/68		10-3/4"	
Production casing	In/lb/ft.		9 ⁵ / ₈ "/47		7 ⁵ / ₈ "/33.7
Internal yield pressure	bar	238	326	278	352
Shut in pressure	bar	221	250/267	221	250/278
Ratio		1.08	1.3/1.22	1.26	1.41/1.27

Collapse pressure

Collapse pressure was calculated in accordance to the collapse pressure of API (1994), depicted in Figure 14. Collapse resistance was plotted as a function of temperature for casing sizes considered for the project. The temperature range for the design was 20-500°C.

Heating or cooling strain

Temperature changes of the casing cause strain (tension or compression) due to hindered thermal expansion. The effects of plastic yield and of stress relaxation with time were considered when setting the casings and for well operation procedures and down hole workovers to ensure thermal cycling was kept to the minimum.

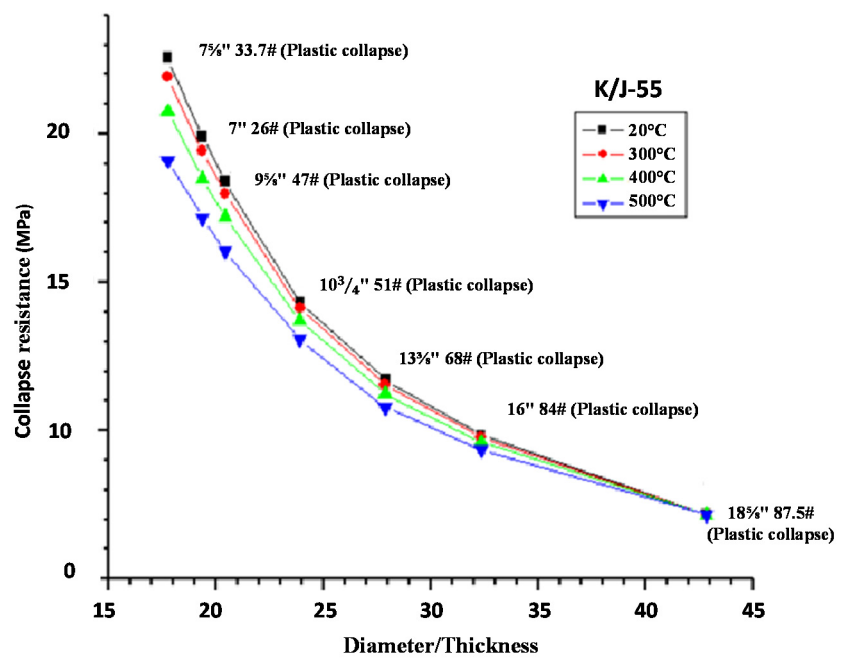

FIGURE 14: Collapse resistance of casing vs Diameter/Thickness ratio and effect of Temperature (Thórhallsson, et al., 2010)

5.1.4 IDDP well cementing

A Peak C-Flex RPL valve was used to carry out cementing but the seals melted due to high temperatures. A C-flex RPL is a sleeve-based cementing valve that allows access to the casing to casing annulus without reducing integrity of the casing string. By installing the C-Flex RPL, casing OD and ID are maintained. When the operation is completed, the C-Flex can be permanently locked in position. Cementing and displacing using a C-flex RPL is shown in Figure 15. The Peak C-Flex RPL is a mechanically operated valve which is operated by using a cementing tool attached to the drill pipe. The cementing tool is equipped with two latching dogs that match the latching profile inside the C-Flex RPL.

When the C-Flex RPL is operated, the cementing tool is latched into the C-Flex RPL and a force of 12-14 tons is set down to the valve, which opens leaving access to the annulus for cementing. Once the operation is done, 6 tons over-pull is applied to the cementing tool and the C-Flex RPL will close. When the valve closes it can be set in a permanent position by adding a force of 45 tons over-pull. The process is illustrated in Figure 14. The temperature rating for the C-Flex RPL is 130°C, but the seal can be changed to a more temperature resistant seal (Thórhallsson, et al., 2010). During cementing of the IDDP wells, the seals melted due to the very high temperatures.

Well IDDP-1 was drilled down into molten magma; it was possible to set a steel casing in the bottom; superheated, high pressure steam blew for months at temperatures exceeding 450°C.

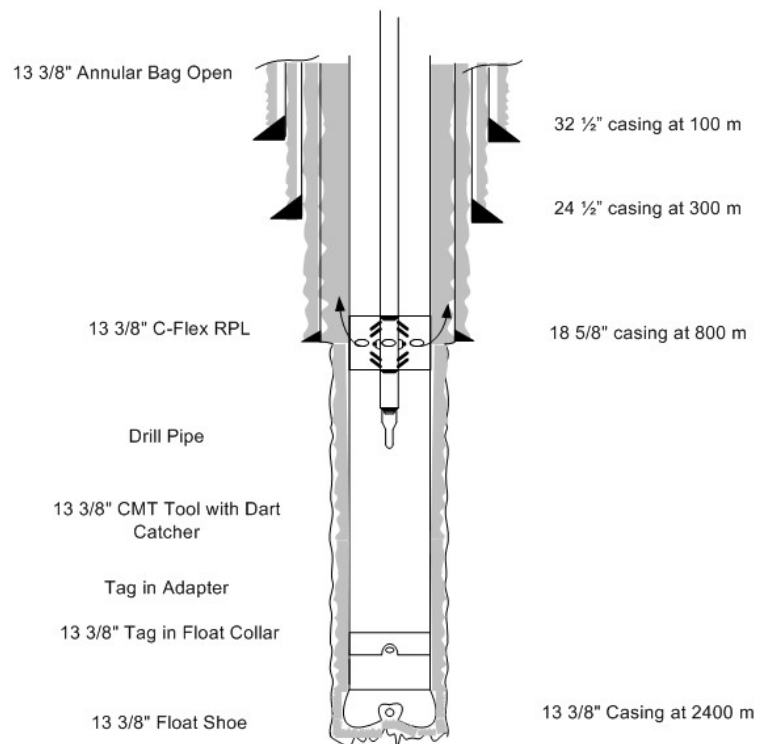

FIGURE 15: Inner string cementing with C-Flex RPL procedure (Thórhallsson, et al., 2010)

6. WELL WORK-OVER

The production casing string in a geothermal well can be subject to internal and external corrosion from the production or reinjection fluid on the inside of the casing and from the reservoir fluid on the outside of the casing. The casing can also be damaged by mechanical wear, particularly if the production casing is deviated from the vertical. Casing implosion can have a marked effect on the productivity of a well, immediately after the first discharge; severe cases can choke the well. Failures have the potential of allowing fluid to escape from the well into the surrounding formation or breaching to the surface. Causes of casing failure are:

- I. Casing can part while running in hole or part due to excessive pull when stuck;
- II. Excess pressure while bumping the plug too hard while cementing can cause burst failure;
- III. Wear caused by drilling below the casing or casing damage while fishing inside the casing;
- IV. Movement of plastic formations during completion operations;
- V. Internal or external corrosion or rod wear during producing life of a well; and
- VI. Subtle failure, undetected failure.

General classes of casing failures are divided into:

Casing leaks: these commonly occur with most failures. Major causes are improper make up during running, drill pipe wear, corrosion failure, and mechanical wear during the producing life of a well.

Split or burst casing: Caused by applying excess internal pressure, directly caused by operations or indirectly caused by inadequate design. Casing can also burst because of structural defects including

slag inclusions in the casing wall and uneven wall thickness. Split or burst casing due to mechanical action during operations may be due to faults in the program design. Casing may be split by jarring a packer loose with a malfunctioning slip segment. Casing may split when long heavy liners are set.

Parted casing: Always occurs at a connection, especially for special connections where the strength of the connection is less than the strength of the pipe body. Casing failures due to parting can be caused by design, operation or mechanical failure due to improper construction. Other causes of parted casings are pulling casing apart while working a stuck casing, bumping the plug too hard and during cementing.

Collapsed casing occurs while squeezing or treating below a packer set in the casing. This can occur when there is a poor cement job outside the casing (cement channelling), and the tubing casing's annulus is insufficiently pressurized. The pressure below the packer communicates outside the casing and up to the section above the packer.

Once the casing has failed due to one of the above reasons, reconstruction has to be done in order to continue using the well. Different repair methods exist for reconstruction of casings and the method to be selected depends on:

- I. How does the casing failure affect current and future operation;
- II. Is the internal diameter of the casing restricted;
- III. Is the casing worthy of recovering;
- IV. Can the failure be repaired in the normal course of future operations;
- V. Can an extra string of casing be run;
- VI. Can the string be patched or packed off;
- VII. Can casing be plugged or repaired later; and
- VIII. Is the point of failure inside another casing string?

Possible mechanisms for production casing failures are shown in Table 7.

TABLE 7: Production casing failure mechanism (Southon, 2005)

Casing failure mechanism	Conditions	Likely depth
Casing implosion	ΔT and casing to casing entrapment of fluids	Anywhere above shoe of the outer casing (s)
Compression failure in casing or couplings	ΔT and rapid heat up. Also an added condition is severe doglegs	High temperature fields and shallow where ΔT is greatest
Sulfide stress cracking	Temperatures below 80°C and high stress areas	Shallow with cold shut in conditions
Early (< 2 years) corrosion or casing holing (internal)	Sections with worn (thinned) casing or wells with very aggressive (low pH) production fluids	For aggressive fluids the first sign of problems is corrosion at the well head
Delayed corrosion (3-5 years)- Internal	Condensate level in shut in wells	At the water gas interface of shut in wells
Corrosion evidence after 5 years (external)	Corrosive fluid penetrating along micro fractures in casing cement	Any depth on the production casing

6.1 Ways of determining casing failures

6.1.1 Video record

Using downhole video cameras, casing failures can be readily identified by the deformation being segmented to one side of the casing circumference. Figure 16 shows a casing break, at a depth of 310.9 m, inside the buttress thread coupling. Video cameras can also show a non-symmetric collapse, probably a reflection that fluid is trapped in liner streaks rather than as a full annular slug of fluid during cementing. Collapse is normally located in the body of the casing and not near the couplings. At the couplings of the production casings, the trapped fluid occupies less annular space. Video cameras also show heavy scale build up on the casings and sections which have thinned out. Some videos of casing collapse have revealed relatively minor inward bulging of the casing wall, indicating a relatively small pocket size of trapped fluid

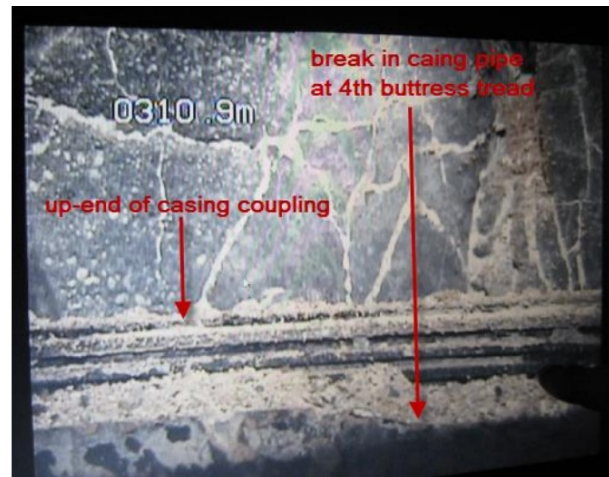

FIGURE 16: Casing break at 310.9 m (Thórhallsson S., 2003)

6.1.2 Cement bond logs

A cement bond log (CBL) uses an acoustic amplitude curve to indicate cement bond integrity. CBL uses conventional sonic log principals of refraction to make its measurements. Sound travels from the transmitter, through mud and refracts along the casing mud interface and back to the receivers. The amplitude is recorded on the log in millivolts or as attenuation in decibels/foot or as a bond index. A travel curve is also presented. The actual value measured is the signal amplitude in millivolts. Attenuation is calculated by the service company based on its tool design, casing diameter and transmitter. Good cement is indicated by low amplitude, high attenuation and a high bond index. In a casing that is still unbonded (high amplitude railroad tracks on early arrivals on the VDL), amplitude curve reads high, BUT: late arrivals on VDL have shape and track porosity log shape. Figure 17 shows high amplitude variation at depths with casing problems and inadequate cementing.

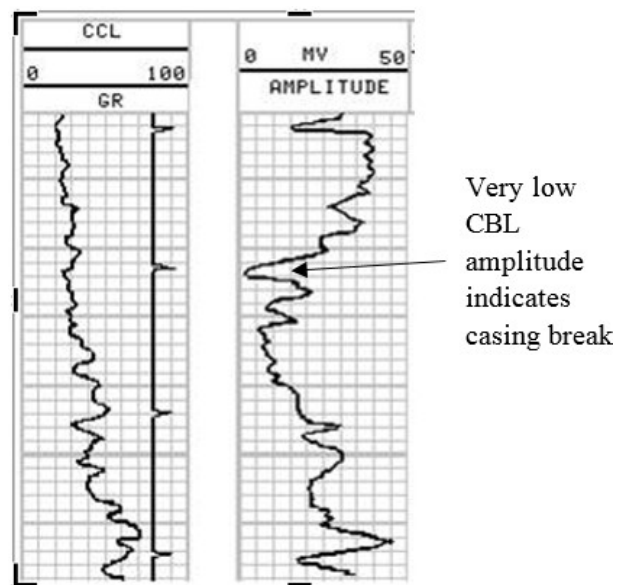

FIGURE 17: Cement bond output (Steingrímsson, 2014)

6.1.3 Caliper logs

Calipers are electronic tools equipped with several arms to measure the diameter of casing. Arms centralize the tool in the hole. An electrical motor inside opens and closes the tool, controlled at the surface through the cable. The positions of the arms are detected through a variable resistor. Figure 18 shows a calliper log with a casing break at 175 m and the calliper tool, respectively.

Caliper logs are used to (Steingrímsson, 2014):

- Evaluate depositions in casings: calcite or silica
- Evaluate casing corrosion
- Evaluate casing damages

The practical solution for casing implosion is to take all necessary measures to avoid fluids, including unset cement getting into the well bore (Southon, 2005).

6.2 Casing reconstruction techniques

Tie back casing design

Run at the bottom of the tie back stub liner or casing, the tie back sealing nipple has multiple packing elements which provide a seal against the polished surface of the tie back sleeve. Tie back casings are usually cemented by conventionally circulating the slurries. The job is performed before landing the seal nipple into the tie back sleeve. However, the cementing may also be conducted with the tie back casing in place, using a stage collar located above the sealing nipple. Tie back liners must be cemented after their liner hangers have been set with the seal nipple landed into the sleeve. A stage collar can be run on top of the seal nipple, in the open position. The liner wiper plug must be able to land on the upper seal and close the collar ports. Apart from the special procedures given above, the considerations applicable to all cement jobs equally apply to tie back liner cementing. In most cases, hydrostatic pressures are not significant because cementing is done between casings and usually with extended slurries. The use of washes ahead of cement slurries will prevent mud or cement contamination and help to remove the mud from the annular space. This is especially important in tie back liner cementing, where no bottom plug is used to separate the mud from the cement inside the liner. If a completion fluid is in the hole, compatibility with the cement must be checked or large volumes of fresh water pumped ahead of the slurry. Salts used in completion brines may drastically affect a cement slurry's thickening time, causing a premature set or, conversely, resulting in excessively long times for the development of early compressive strength. Figure 19 shows tie back liner cementing. Tie back casing design has these advantages when applied to geothermal wells:

- I. Casing worn thin due to drilling can be covered over with new casing (tie back) at the end of drilling a well.

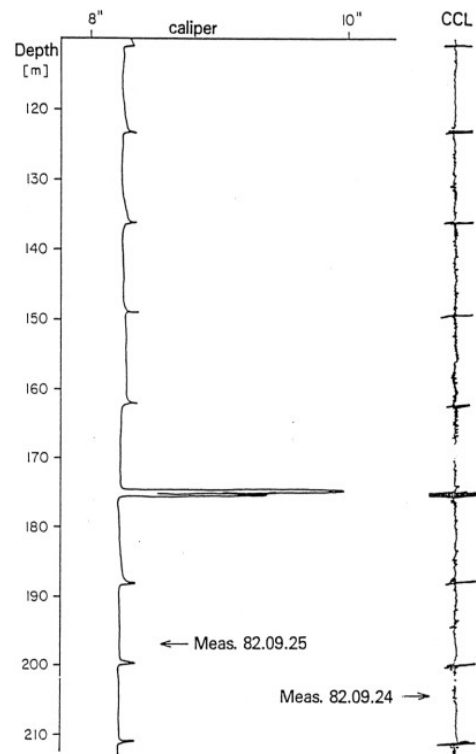

FIGURE 18: Caliper log (Steingrímsson, 2014)

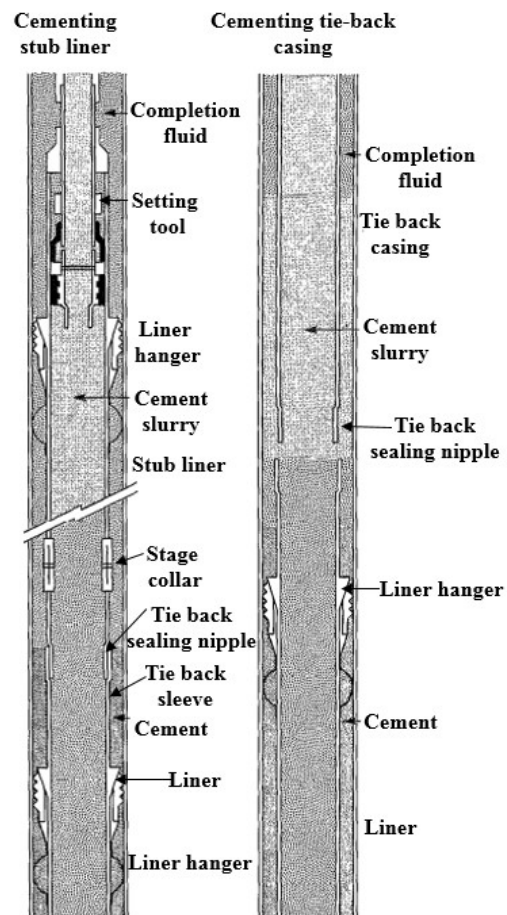

FIGURE 19: Tie back casing design (Nelson, 1990)

- II. It provides the opportunity for a perfect cement job in the critical casing to casing section of the well.

The tie back design has some drawbacks which are:

- I. The connection between the tie back and the liner will invariably leak down the lap during the productive life of the well.
- II. The tie back string is short and invariably lighter than a single production casing. If pre-tensioning is not imparted to the tie back, the tie back will yield in compression if the change in temperature (ΔT) is sufficiently large. For tie backs with buttress threads, this yielding will result in a loss of pressure containment. This yielding can be prevented if the maximum heat-up temperatures are known beforehand and the tie back is pre tensioned before cement sets. This will necessitate the use of latch down slip assemblies in the tie back receptacle or above the receptacle (Nelson, 1990).

For cementing the tie backs, a drillable bridge plug is required to be set in the liner to isolate the newly drilled production hole. The plug should be located immediately below or close to the tie back receptacle to avoid any fluid contamination of the slurry. A thick gel with a relatively high density should be used to prevent the heavy tie back cement slurry from falling through the liquid column.

Casing wear is more concentrated on built up sections of a deviated well. A tie back casing can be run in wells that have already been completed by first using the casing cutter to cut the liners up to just below the cold zone in the well. A drillable bridge plug should be located immediately below or close to the tie back receptacle to avoid any fluid contamination of the slurry.

6.2.2 Cement squeeze

If a casing has parted or there is casing damage and the casing is out of position, the casing can be milled before a cement squeeze job is done to secure the casing. If there is an obstruction while going in the hole, the string should be pulled out of the hole. An impression block is run in the hole to locate the casing damage. The impression block is pulled out, then a milling tool, either a taper mill or a water melon mill, is then run in the hole to mill the hole section clear. The hole is cleaned prior to running a bridge plug to a section below the casing damage depth. The bridge plug (drillable isolation tool) should be able to hold firmly inside the casing and should not allow cement below. Sand is put on top of the bridge plug to avoid its direct contact with the cement slurry. Cement is pumped down and forced through the leaking casing, as shown in Figure 20, until the damage is sealed.

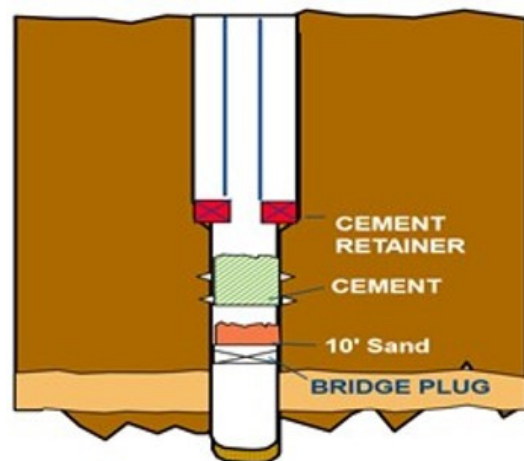

FIGURE 20: Cement squeeze job set up

Other methods that have been used for casing repair are:

- I. Running a blank sleeve inside the casing to seal off the damage. This option will have to be weighed with position reduction in well output due to a drop in mass flow inside the new casing. Liner breaks have been known to occur in some wells due to corrosion, material failure or inadequate liner design. This can be addressed by running a liner sleeve which would protect the well from collapse (Malate, 2003).
- II. Near surface damage can be repaired by excavating a pit around the well and replacing the bad casing with a new one. Excavations as deep as 12 m have been dug in Iceland to replace to replace a full length of casing down to the first threaded connection (Thórhallsson, 2003).
- III. Milling the damaged casing and squeezing cement behind the casing.

6.3 Reconstruction for Menengai wells

Tie back casing-Menengai well MW02

Menengai well MW02 has its production casing set at 790.8 m, as shown in Figure 21. The well has a cold inflow at 1300 m. A cemented casing needs to be run to a depth of 1400 m to seal off the cold inflow. The procedure will involve:

- I. Run in-hole a casing cutter and cut the liners at a depth below 1400 m.
- II. Run in-hole plain 7" casings with a bridge plug at the bottom.
- III. Run the casings with an expandable casing packer (ECP) as part of the casing string.
- IV. After running in-hole, inflate the ECP by pressurizing the casing.
- V. Once the ECP is inflated, cement the annulus through slots in the non-return valve above the ECP.
- VI. Wait for the cement to set.
- VII. Drill out the cement and the bridge plug to access the 7" slotted liners below. Figure 22 shows cementing of the tie back casing using ECP.

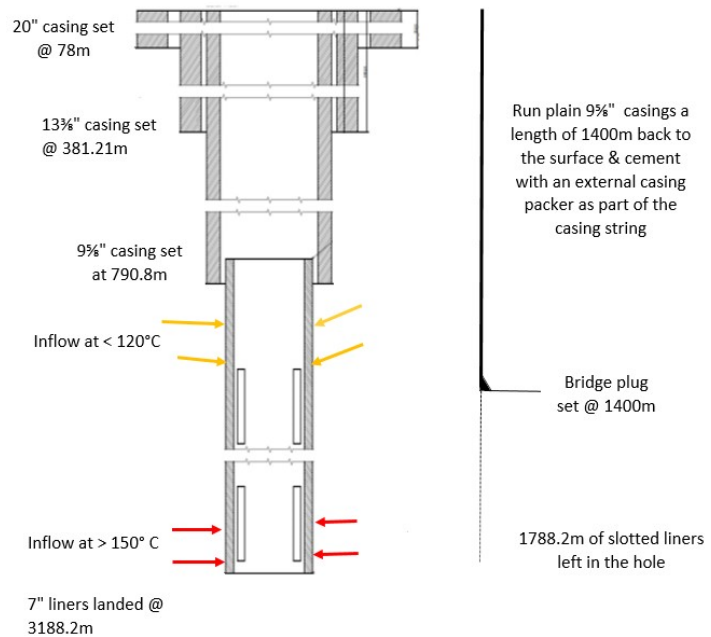

FIGURE 21: Tie back casing reconstruction for Well MW02

Scab liners

Another approach used for casing reconstruction is the use of scab liners or straddle packer assemblies. These approaches are more reliable and are longer-term solutions than cement squeezes, but they are somewhat limited in the length of damage that can be covered. In addition, they result in a greatly reduced hole size, which can severely affect both the productive capacity and access for subsequent remediation. This method is mostly applicable in the oil and gas industry.

7. CONCLUSIONS AND RECOMMENDATIONS

For the Menengai wells, it is feasible to run 9 5/8" K55 production casing to a setting depth of 1400 m to safely seal off shallow upper feed zones. Setting the production casing at deeper depths of up to 1400 m will help prevent scaling, which is a common problem in the Menengai field due to production from the shallow reservoirs. Caliper logs should be run before casings are run to accurately determine the amount of cement to be pumped.

To cement the production casings effectively, an inner string method of cementing should be used to fill up the cement during the primary cement job. For wells with major losses, temperature logs should be run to determine the location of the loss zone. Primary cementing should be done to the loss zone, then an immediate top job done. An inner string cementing method provides a more accurate way of determining the cement slurry volumes to be pumped and takes less time to displace the cement since less displacement capacity is used. Inner string cementing takes less time to execute and there is less chance of cement contamination by water. Cement bond logs should be done as part of the cementing process to evaluate the effectiveness of the cementing job; where it is noted that the cementing is not done properly, remedial cementing should be done before proceeding and drilling the next phase.

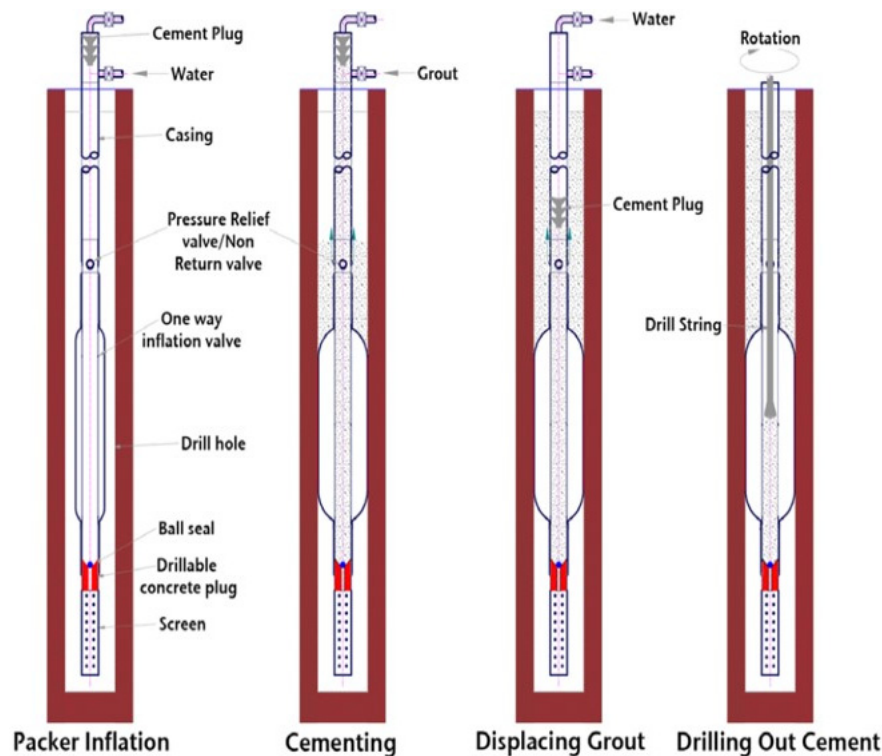

FIGURE 22: Cementing tie back with an External casing packer in the casing string (Nelson, 1990)

Completed wells that have a cold inflow below the production shoe can be worked-over by installing an extra casing string and cementing in order to seal the cold inflows. This can be done most effectively using the tie back casing design. The tie back casing design, with an external casing packer (ECP) as part of the string, provides better sealing to the formation once the packer has been inflated and cementing is done. For wells with high downhole temperatures that exceed the limit set for the ECP, a bridge plug with a cementing plug set on top is used to isolate the lower zone before running the new casing. The design can also withstand high temperatures and high pressures in geothermal conditions.

ACKNOWLEDGEMENTS

My sincere appreciation goes to UNU-GTP, the Government of Iceland and Geothermal Development Company Limited, Kenya for awarding me an opportunity to study in Iceland. I wish to specially thank Mr. Lúdvík S. Georgsson, Director, and Mr. Ingimar G. Haraldsson, Deputy Director. Many thanks to María S. Guðjónsdóttir, Thórhildur Ísberg, Málfríður Ómarsdóttir, Markús A.G. Wilde and Rósa S. Jonsdóttir and all the staff of Orkustofnun and ISOR for facilitating my academic endeavours and stay in Iceland. To all, your commitment is humbling. Cheers for the 2014 UNU-GTP fellows for the amazing time we had together.

I am indebted to my supervisor, Mr. Arnar Bjarki Árnason, for his valuable input, fruitful ideas, critical comments and encouragement during my project work, to Mr. Sverrir Thórhallsson for advice during project work, and my colleague, Francis Wanjohi, for providing me with invaluable data.

My deepest gratitude to my family for the support I have received: my dear mom, Irene Naliaka Khaemba, and my two brothers for being my source of strength.

REFERENCES

- API, 1994: *Bulletin 5C3 on formulas and calculation for casing, tubing, drill pipe properties*. American Petroleum Institute, Exploration and Production Dept.
- Atlas Copco, 2011: The predator drilling system. Atlas Copco Oil and Gas Rigs, website: www.atlascopco.com/images/ac_predator_brochure_lores_tcm45-3526711.pdf.
- Bett, E.K., 2010: Geothermal well cementing, materials and placement techniques. Report 10 in: *Geothermal Training in Iceland 2010*. UNU-GTP, Iceland, 99-130.
- Bomco, 2011: Bomco VFD AC rig 2000HP. World Oil and Gas Central, website: www.worldoils.com/marketplace/equipdetails.php?id=668.
- Elders, A., and Fridleifsson, G.Ó., 2010: The science program of the Iceland Deep Drilling Project (IDDP): Study of supercritical geothermal resources. *Proceedings of the World Geothermal Congress 2010, Bali Indonesia*, 9 pp.
- Gabolde, G. and Nguyen, J.P., 2014: *Drilling data handbook* (9th edition). Editions Technip, Paris, 576 pp.
- Hole, H., 2008: *Geothermal well design - casing and wellhead*. Petroleum Engineering Summer School, Workshop 26, Dubrovnik, Croatia, June 2008.
- Hossein-Pourazad, H., 2005: High temperature geothermal well design. Report 9 in: *Geothermal training in Iceland 2005*. UNU-GTP, Iceland, 111-123.
- Lopeyok, T., 2014: *Borehole geology of Menengai well MW-19*. GDC, Kenya, unpublished report.
- Malate, R.C.M., 2003: Well intervention techniques. In: Fridleifsson, I.B., and Gunnarsson, M.V. (eds.), *Lectures on the sustainable use and operating policy for geothermal resources*. Short course prior to the International Geothermal Conference, IGC 2003. UNU-GTP, Iceland, 219-244.
- Mungania, J., 2004: *Geological studies of Menengai geothermal prospect*. KenGen Ltd., Kenya internal report, 18 pp.
- Nelson, E.B., 1990: *Well cementing*. Schlumberger Educational Services, Texas, 487 pp.
- Njue, L., 2013: *Borehole geology of Menengai well MW-02*. GDC, Kenya, unpublished report.
- NZS, 1991: *Code of practice for deep geothermal wells*. Standards Association of New Zealand, Wellington, NZ, New Zealand Standard 2403, 93 pp.
- Southon, J.N.A., 2005: Geothermal well design, construction and failures. *Proceedings of the World Geothermal Congress 2005, Antalya, Turkey*, 6 pp.
- Stefánsson, V., and Steingrímsson, B., 1980: Production characteristics of wells tapping two-phase reservoirs at Krafla and Námafjall. *Proceedings of the 6th Workshop on Geothermal Reservoir Engineering, Stanford University, Stanford, CA*, 49-59.
- Steingrímsson, B., 2014: *Geothermal well logging, cement bond logs and caliper logs*, UNU-GTP Iceland, unpublished lecture notes.
- Thórhallsson, S., 2003: Geothermal well operation and maintenance. In: Fridleifsson, I.B., and Gunnarsson, M.V. (eds.), *Lectures on the sustainable use and operating policy for geothermal resources*. Short course prior to the International Geothermal Conference, IGC 2003. UNU-GTP, Iceland, 195-217.
- Thórhallsson, S., Pálsson, B., Hólmgeirsson, S., Ingason, K., Matthíasson, M., Bóason, H.A., Sverrisson, H., 2010: Well design and drilling plans of the Iceland deep drilling project (IDDP). *Proceedings of the World Geothermal Congress 2010, Bali, Indonesia*, 8 pp.

APPENDIX I: Menengai production casing cementing design

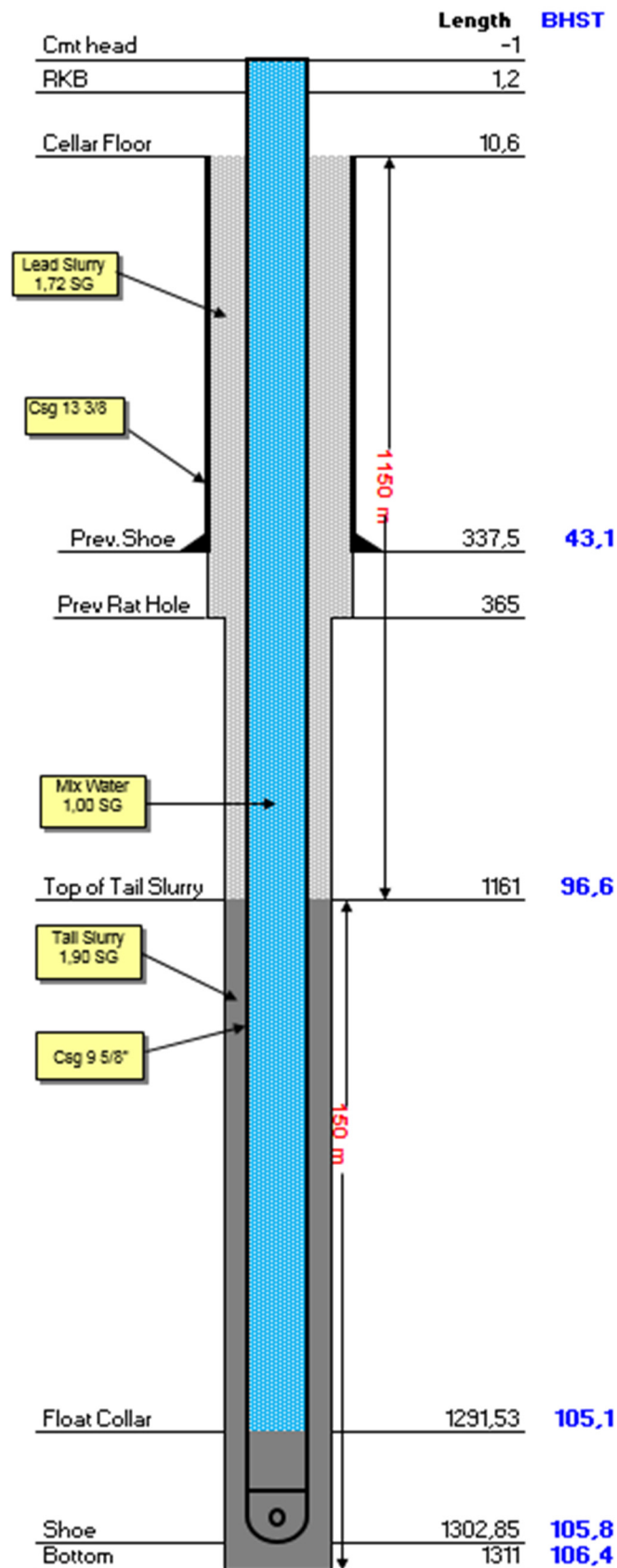

APPENDIX II: Laboratory report for 9%" cement slurry

GEOHERMAL DEVELOPMENT COMPANY
LABORATORY REPORT

This report is the property of GEOHERMAL DEVELOPMENT COMPANY and is intended for private information of the below named party. This report nor any party thereof may not be published or disclosed to a third party without the written approval of GDC.

Project #	GDC Menengai Kenya	Date	21-Aug-2014
Requestor	GDC-CMTNG	Report No.	GDC-CMT-0073
Well	MW-09A	Lab Tech.	Jowen Besaga
Rig	Kifaru-2 (Rig No.4)	Mud Type	N/A
Job Type	9-5/8 Casing Cement Slurry	Mud Wt. ppg	N/A
Test Reference	Confirm Test	Spacer Design	N/A
Sample Source	Laboratory/Field	Spacer Wt. ppg	N/A

Batch No.	Type	Conc.	Units	Remarks
Aug-14	Savannah Cement	94	#/sk	
	Silica Flour	0.00	%bwoc	
Old CPTDC	Mica	3.00	%bwoc	Dryblend
Old CPTDC	Bentonite Gel	2.00	%bwoc	Dryblend
Old CPTDC	Friction Reducer	0.35	%bwoc	Dryblend
Old CPTDC	Fluid Loss	1.00	%bwoc	Dryblend
New CPTDC	Retarder	0.15	%bwoc	Pre-Hydrate
Lab/Rig	Water	65.56	%	
	Calculated Density	14.34	ppg	1.72 g/cm ³
	Calculated Yield	1.51	cuft/sk	1.00 m ³ /ton
	Water Required	7.39	gal/sk	0.66 m ³ /ton
	Total Mix Fluid	7.39	gal/sk	0.66 m ³ /ton

Measured Density	Required	Tested	Thickening Time	Result
g/cm ³	1.72	1.72	Test Temp. BHCT (°C)	70
Free Fluid			Time to Temp. (min.)	15
Conditioning Time (hrs:min)	0:20	0:20	Initial Pressure (Mpa)	3.5
Conditioning Temp. (°C)	70	70	Final Pressure (Mpa)	10
Test Temp. (°C)	70	70	Initial Bc -	2.6
Test Angle (45°)	45°	45°	40 Bc (hrs:min)	4:23
Free Fluid (%)	<1	0.00	70 Bc (hrs:min)	6:11
Static Fluid Loss			100 Bc (hrs:min)	6:37
Conditioning Time (hrs:min)	0:20	0:20	40-100 Bc Time (hrs:min)	2:14
Conditioning Temp.(°C)	70	70	UCA Test	
Test Temp. (°C)	70	70	Test Temp. BHST (°C)	150
Collected fluid (ml.)		69	Time to 3.45 MPa (hr:min)	3:24
Time (min.)		30.0	24 hr (MPa)	6.05
Measured (ml/30min)	<500	138		
Calculated API (ml/30min)	N/A	N/A		
Rheology	Atm	BHCT	Slurry Design:	
Test Temp.(°C)	27	70	Cement + 3% Mica (DB) + 2% Bentonite Gel	
Fann Reading @			(DB) + 1.0 % Fluid Loss (DB) + 0.35% Friction	
300 rpm	64	60	Reducer (DB) + 0.15% Retarder (PHY).	
200 rpm	52	42		
100 rpm	33	31		
6 rpm	11	4		
3 rpm	7	2		
600 rpm	94	98		
PV	46.5	43.5		
YP	17.5	16.5		
10 Sec Gel		3		
10 Min Gel		9		

NOTE : MIXING SEQUENCE :
 1. Pre-Hydrate Retarder into Mixing Water.
 2. Mix Dryblended Cement with Additives.

NOTICE : This report is the property of GEOHERMAL DEVELOPMENT COMPANY. Any user of the report agrees that GDC shall not be liable for any loss or damage which results from the use of the information in the report. GDC makes no warranties in respect to the information in the report, whether expressed or implied or for fitness for particular purpose.

APPENDIX III: 9%" cement slurry compressive test plot

Well ID: MW-09A
Test Start: 8/20/2014 3:36:08 PM
Test Stop: 8/21/2014 3:36:08 PM

Operator: GDC
Final Compressive Strength: 6.05 MPa
Algorithm: Compressive strength type B (more than 14 lb/gal)

BHST: 150
0.345 MPa @ 1:56:21
3.45 MPa @ 3:24:58

